

Acer S200

User Guide

© 2009 All Rights Reserved

Acer S200 Smartphone User Guide

First issue: 08/2009

Acer S200 Smartphone

Model number: _____

Serial number: _____

Date of purchase: _____

Place of purchase: _____

Table of Contents

Getting to know your smartphone

Features and functions	5
Other sources of help	6
Product registration	7

Chapter 1: Setting Up

Unpacking your smartphone	9
Getting to know your smartphone	10
Installing or removing the battery	12
Installing a SIM card or microSD card	14
Turning on for the first time	15

Chapter 2: Making Calls

Before making a call	19
The onscreen number pad	20
The voice call screen	22
Onscreen call options	23

Chapter 3: Input Devices

The stylus	27
The onscreen keyboard	27

Chapter 4: Messaging

The messaging screen	31
Text (SMS) messages	32
MMS messages	33
Email	36

Chapter 5: Using the Camera

Camera icons and indicators	39
Taking a photo	40
Shooting a video	41
Photo and video options	42

Chapter 6: Advanced Operation

Putting your smartphone in flight mode	45
Comm. Manager	45
Adjusting connection settings	46
Phone settings	50
Managing your phonebook	52
SIM Manager	55
Connecting to a PC and synchronizing	56
Other functions	57
Multimedia playback	59
Satellite Data Update	61
Updating your smartphone	68
Resetting your smartphone	69

Chapter 7: Accessories and Tips

Using the headset	71
Using a Bluetooth headset	71
Using your smartphone as a modem	72
Inserting a microSD card	75

Appendix

FAQ, troubleshooting and error messages	77
Specifications	79
Warnings and precautions	82
Emergency calls	88
Disposal and recycling information	89
Taking care of your smartphone	89
Safety regulations	91

Getting to know your smartphone

Features and functions

Your new smartphone is a multi-functional tool packed with intuitive features and powerful applications that make organizing your information and synchronizing it with your personal activities an easy, efficient task. Your smartphone lets you:

- Access your email while on the move.
- Make calls when connected to a 3G/EDGE/GPRS/HSUPA/HSDPA network.
- Connect wirelessly to your local cellular network to access the Internet and other network features.
- Exchange information between devices that have Bluetooth/WLAN capabilities.
- Enjoy digital media in a home network environment with DLNA-compatibility.
- Easily manage your contacts and social networking interaction.

Product features

- Qualcomm 8250 1 GHz processor
- 512 MB of ROM, 256 MB of RAM
- 3.8" WVGA TFT-LCD touchscreen
- MicroSD memory card slot with SDHC support
- High-density, rechargeable 1350 mAh Lithium Polymer battery (changeable)
- Windows Mobile 6.5 Professional

- Easy-to-use Acer features: Phonebook, Agenda, AcerSync, Phone Dialer with Favorites and Call History, Social Networking, Notification Manager, and Preferences.

Other sources of help

To help you use your smartphone, we have designed a set of guides:

For information on:	Refer to:
Programs on your smartphone and additional programs that can be installed on your smartphone.	This User Guide. Included on the smartphone Companion CD, it provides online reference for using your smartphone.
Up-to-date information regarding your smartphone.	www.acer.com/
Service enquiries	www.acer.com/support/

Product registration

When using your product for the first time, it is recommended that you immediately register it. This will give you access to some useful benefits, such as:

- Faster service from our trained representatives
- Membership in the Acer community: receive promotions and participate in customer surveys
- The latest news from Acer

Hurry and register, as other advantages await you!

How to Register

To register your Acer product, visit our website at **registration.acer.com**. Choose your country and follow the simple instructions.

You can also click **Start > Registration** to register using your smartphone.

After we receive your product registration, you will be sent a confirmation email with important data that you should keep in a safe place.

Chapter 1: Setting Up

Unpacking your smartphone

Your new smartphone comes packed in a protective box. Carefully unpack the box and remove the contents. If any of the following items is missing or damaged, contact your dealer immediately:

- Acer S200 Smartphone
- Stylus
- Battery
- Quick Start Guide
- Companion CD
- USB cable
- AC adapter
- Headset
- Screen protective film

Getting to know your smartphone

Views

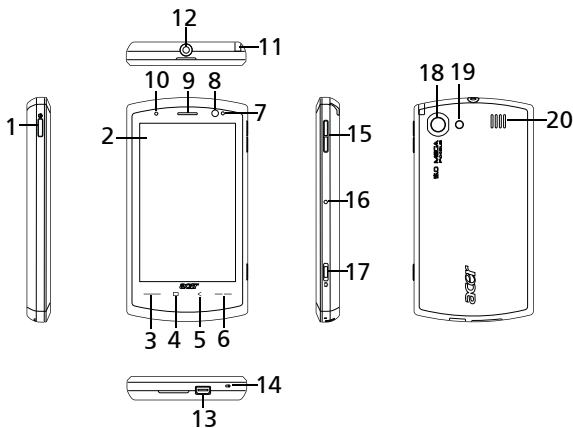

No.	Item	Description
1	Power button	Press to turn the screen on/off or enter sleep mode; press and hold to turn the smartphone off.
2	Touchscreen	3.8-inch, 480 x 800 pixel touchscreen to display data, phone content and enter information.
3	Call button	Activate phone/dial/view recently dialed numbers/answer a call.
4	Home button	Return to the Today screen.
5	Back button	Go back one menu step.
6	End button	Press to end a call.

No.	Item	Description
7	IR LED	Works in conjunction with the Proximity sensor.
8	Proximity and ambient light sensor	Dims the display and deactivates the touchscreen when the device is brought near the face during a call. Adjusts the displays brightness depending on lighting conditions.
9	Phone speaker	Emits audio from your smartphone; suitable for normal use.
10	LED indicators	Indicates battery charge and event status.
11	Stylus	Use to enter information or select items on the touch screen.
12	3.5 mm headset jack	Connect to headset.
13	Mini USB connector	Connect to a USB cable/headset/charger.
14	Microphone	Internal microphone.
15	Volume up/down button	Increases or decreases the phone volume during calls.
16	Reset button	Clear your smartphone's memory.
17	Camera button	Activate the camera or take a picture. Press down halfway to auto-focus.
18	Camera	A 5-megapixel Auto-Focus camera.
19	Flash	Provides illumination for low light picture taking.
20	Handsfree Speaker	Emits audio from your smartphone; suitable for handsfree use.

LED indicator

Color	State	Description
Red	Steady	Battery is charging.
	Slow flashing	Battery charge is low.
	Flashes twice rapidly	Battery charge is critically low.
	Flashes rapidly	Battery level is too low to start the smartphone.
Blue	Slow flashing	New event (missed call, new SMS/MMS/email, appointment, etc).
Green	Steady	Battery is fully charged; you should unplug the charger.

Installing or removing the battery

Your smartphone uses a replaceable battery to provide power. It is packed separately from your smartphone and needs to be inserted and charged before you can use the smartphone.

Installing the battery

Slide your fingernail into the gap between the battery cover and the smartphone. Gently apply pressure upwards to remove the battery cover.

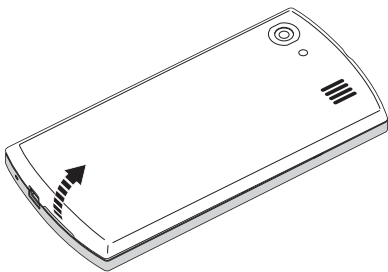

Place the battery into the battery compartment, lining up the battery connectors with those at the middle of the compartment.

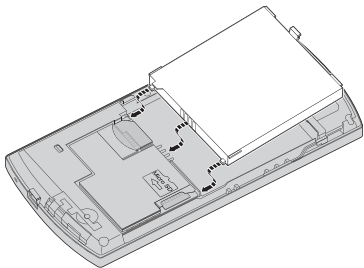

Insert the tabs on the bottom of the battery cover into the slots in the smartphone.

Carefully press the top of the cover until the cover snaps in place.

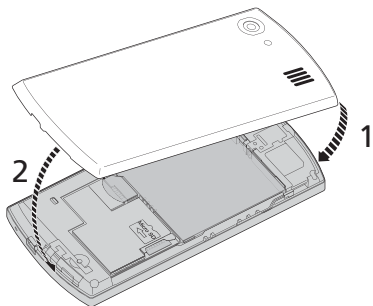

CAUTION: Risk of explosion if battery is replaced by an incorrect type. Dispose of used batteries according to the manufacturer's instructions.

Charging the battery

For initial use, you need to charge your smartphone for eight hours. After that you can charge it each day to recharge the battery to full capacity.

Connect the AC adapter cord to the mini USB connector on your smartphone.

Removing the battery

Open the battery compartment as shown in **“Installing the battery”** on page 12. Lift the battery out of the compartment using the clip on the top of the battery.

Replace the battery cover as described above.

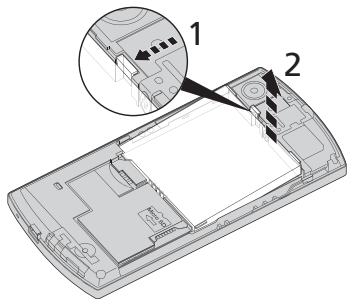

Installing a SIM card or microSD card

To take full advantage of your smartphone's telephony capabilities, you must install a SIM card. The SIM card holder is located at above the battery bay.

Additionally, you may wish to increase your smartphone's storage by inserting a microSD card into the slot provided. This is next to the SIM card slot.

1. Turn off the smartphone by pressing and holding the power button.

2. Open the cover and remove the battery as described in **“Installing or removing the battery”** on page 12.
3. Insert the SIM or microSD card as shown.
4. Replace the battery and battery cover.

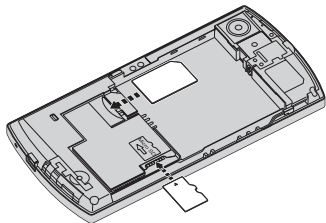

SIM card lock

Your smartphone may come with a SIM card lock, i.e., you will only be able to use the SIM card provided by your network operator.

To cancel the SIM lock, contact your network provider.

Turning on for the first time

To turn on your smartphone for the first time, press and hold the power button until the system bootup screen appears. The smartphone will vibrate during the boot sequence. Follow the setup screens to set up your smartphone.

Entering your PIN

When you install a SIM card for the first time, you will have to enter a PIN using the onscreen number pad.



Important: Depending on your PIN settings, you may be asked to enter the PIN each time you switch on the phone function.

If the PIN you enter is incorrect, a warning message appears.

Activating a new SIM card

If you are using your SIM card for the first time, it may require activation. Contact your network operator for details on how to do this.



The Today screen



After rebooting, your smartphone will display the Today screen. This screen gives you quick, icon-based access to many of the frequently-used features of your smartphone.

The first time you start your smartphone, you will see shortcuts and function icons on the screen.

Some of them can be changed, others not.



Icon	Description	Changeable
	Opens the phone dialer to make a call.	No
	Opens the Windows Messaging program so you can send an email, SMS or MMS.	No

Icon	Description	Changeable
	Opens the Phonebook.	No
	Opens Internet Explorer so you can surf the Internet.	Yes
	Opens Windows Media Player so that you can enjoy audio or video files.	Yes
	Opens the Facebook application so that you can interact with other people on this popular Social Networking site.	Yes
	Locks the screen: Swipe the Lock icon to the left or right to unlock the screen.	No
	Opens the Windows Home screen.	No
	Allows you to change or add icons (you can add three more icons) to the Today screen.	No

Changing or removing shortcuts

Tap  to add, change or delete the changeable shortcuts.

If you tap the **+** on a shortcut placeholder that is not occupied, you will be taken directly to a screen that lists all the applications available on your smartphone.

If you tap on an already-defined shortcut, you will be asked if you want to change the shortcut or if you want to remove the shortcut. Tap **Cancel** to retain the shortcut.

Tap  to save your changes and exit.



Connecting to your PC and synchronizing data

You can synchronize the data on your smartphone with the data on your PC using the supplied USB sync cable and the Windows Vista Sync Center or ActiveSync.

Refer to **“Connecting to a PC and synchronizing”** on page 56 for more details on connecting and synchronizing.

Chapter 2: Making Calls

This chapter shows you how to make phone calls, and the various options available to you during your call.

Before making a call

The phone function needs to be turned on before you can make a call; you can activate the phone from the Comm. Manager (refer to **“Comm. Manager” on page 45**).

1. To access the Comm. Manager, tap **Start > Settings > Connections > Comm. Manager**.
2. Tap the phone connection icon so it displays **On**.



Making a call

1. From the Today screen, press the Call button to open the onscreen number pad.
2. Enter the number you wish to dial.
3. Press Call button or  to make the call.
4. To end the call, press the End button or

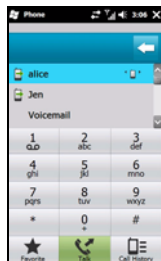

The onscreen number pad

The onscreen number pad allows you to enter numbers to dial.

To access the onscreen number pad press the Call button or tap **Phone** () and press **Show Keypad**.



Making a call to one of your contacts

1. Your contacts will be displayed above the onscreen number pad.
2. Tap a contact to pull up their detailed information.
3. Tap **Call** (), to call the displayed contact.

Dialing a number from Call History

Your Call History is also displayed above the onscreen number pad, and displays recent received, dialed, and missed calls.

Tap a number to view the call details. To redial any number in the call history, select the number and press the Call button or tap **Talk** ().

Missed calls will be displayed in the telephone icon on the

Today screen as well as at the top of the screen using the  icon.

Dialing from other applications

You can dial numbers quickly and easily even when using other applications.

1. Press **Start > Phone**.
2. Make your call.
3. When you have finished your call, tap **X** in the top right corner of the screen, to return to the application you were using before you made the call.

Dialing an international number

When dialing international numbers, there is no need to enter the international direct dialing prefix ('00' etc.) before the country code. Simply tap and hold **+0** until **+** appears onscreen.



.....
Warning: International call rates can vary greatly depending on the country you are calling and your network provider. We suggest you check all call rates with your network provider, to avoid excessive phone bills. If you are using your Acer S200 Smartphone abroad, roaming charges will apply. Consult your network provider for roaming rates specific to the country you are visiting before you leave.
.....

The voice call screen

Once you have dialed your number the voice call screen appears, where several options are available.

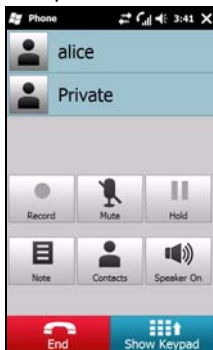

Item	Description
	Record the call.
	Mute the call.
	Put the current call on hold.
	Add a note.
	Enter the Phonebook.
	Turn the speaker phone on.
	End the call.
	Display the keypad.



Note: Certain options are only available during a call. These menu items are greyed out when not in a call.

Onscreen call options

Answering a call

Press  to answer a call.

Rejecting a call

Press the **End** button or  to decline the call.

Ending a call

To end a call press .

Recording a call



To record a call, press .

Putting a call on hold

To put a call on hold, tap **Hold** () on the voice call screen. Tap again to resume the call.



Swapping between calls

When you receive a second call while already on a call, a notification message will appear.

1. Press **Swap** () to answer the incoming call and the first call will be put on hold.
2. Tap **Swap** () on the voice call screen to switch between calls.

Conference calls

If you have one or more calls on hold and another online, you can combine all calls to create a conference call.

1. Tap **Merge Call** (). All calls are combined.
2. Tap **End** () and all participants will be disconnected.

Using the speakerphone

The speakerphone function allows you to make calls without having to hold the Acer S200 Smartphone. This handsfree function is especially useful for multitasking.

To activate the speakerphone, tap the **Speaker On** () on the voice call screen. Tap **Speaker Off** to disable the speakerphone.



Adding notes

You can write or type notes during a call to record important information and view it at a later date.

1. Tap **Note** () on the voice call screen.
2. Use the onscreen keyboard to enter letters and characters or the stylus to write handwritten notes.
3. Tap **OK** when you have finished to save the note.

To view the notes at a later date, tap **Start > Notes**. Tap the note you want to open and view.

Muting a call

To mute a call, tap **Mute** () on the voice call screen to switch off the microphone. Tap **Unmute** () to switch the microphone back on.

Saving a dialed number to contacts

You can save a number you have dialed to your contacts for future use.

1. Select the number from the Call History list, and tap **Save to contacts**
2. Select to save it in the **SIM Card** or **Phone**.
3. Enter the contact's information and tap **Save**.

Redialing a missed call

When you have a missed call, the  icon appears at the Today screen, while the number will display how many calls were missed.





1. Tap **Phone** to display the missed call details.
2. Select the call from the list and press  or tap **Call**.

Call History

View recent calls by accessing Call History: open the onscreen number pad by the Call button; then tapping **Call History** (.

Call History Menu options

There are various options available in the Call History Menu.

- Tap (, ) to organize the call history view. For example, tap (, ) to cycle through All, Missed, Dialed, and Received calls.

Chapter 3: Input Devices

This section will take you through the various input methods available to you on your Acer S200 Smartphone.

The stylus

The stylus is used to select items and enter information. Carefully remove the stylus from its holder to use.

Tap: Touch the screen once with the stylus to open items and select options.

Drag: Hold the stylus on the screen and drag across the screen to select text and images. Drag on a scroll bar to scroll up and down the screen.

Tap and hold: Tap and hold the stylus on an item to see a list of actions available for that item. On the pop-up menu that appears, tap the action you want to perform.

The stylus is also used for handwritten input. Refer to **“The onscreen keyboard” on page 27** for more details.

The onscreen keyboard

You can activate an onscreen keyboard in certain applications when entering data.

Tap the keyboard icon at the bottom of the screen to display the keyboard. Tap again to hide the keyboard.



Tap the arrow next to the keyboard symbol to select different input options.

Mode	Description
Block Recognizer*	Write using letters, numbers, symbols and punctuation marks to be converted to text.
Easy Keyboard (Default)	Displays a standard keyboard. Tap to enter letters, numbers and use function keys.
Keyboard	Displays a compact keyboard.
Letter Recognizer*	Write uppercase letters, lowercase letters, numbers and punctuation marks to be converted into text.
Transcriber*	Use the stylus to write in cursive, mixed or print handwriting to be converted into text.



.....

Note: The handwriting function can take some practice getting used to. Tap the ? symbol, visible when one of the handwriting options (*) is active, to view writing demonstrations and access the Help menus.

.....

Tap **Options** from the keyboard menu to adjust options and settings for each input mode.

Enabling word completion

Your smartphone makes writing emails, messages and documents more efficient with the help of the word completion feature. This feature suggests words as you type.

1. Tap **Start > Settings > Personal > Input > Word Completion** tab.
2. Select the options you want to activate.
3. Tap **OK** to confirm and save.

Other input options

You can also configure voice recording options, zoom levels and grammar rules on the Input Settings screen.

1. Tap **Start** > **Settings** > **Personal** tab > **Input** > **Options** tab.
2. Select and configure the settings as appropriate.
3. Tap **OK** to confirm and save.



.....
Note: Refer to the Help menus for more information on adjusting input settings.
.....

Chapter 4: Messaging

This chapter shows you how to set up and use the SMS, MMS and email functions of your smartphone.

The messaging screen

All SMS, MMS, and email messages are accessed via the messaging screen.

To access the messaging screen, tap **Text** (). Then tap the drop-down menu in the top left corner of the messaging screen to view the folder list.

All email accounts, SMS and MMS folders are displayed here. Tap on the plus sign next to each folder to view the sub folder list. Each folder features the following subfolders:

- Deleted Items: Displays all messages you have selected to delete.



.....
Note: To completely erase messages, you will need to delete them from the Deleted Items folders as well. Tap **Menu > Tools > Empty Deleted Items** to accomplish this.
.....

- Drafts: Displays all draft messages.
- Inbox: Displays all received messages.
- Outbox: Displays messages in the process of being sent.
- Sent Items: Displays all sent messages.

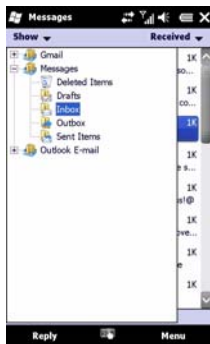

Tap a subfolder to open it. Tap **Inbox** to return to the main messaging screen. Tap **Menu** for a list of options appropriate to the selected folder.

Managing your folders

You can select synchronization, download and other settings for certain folders. To manage your folders, tap **Menu > Tools > Manage Folders**, tap and hold on the folder name to open a menu of action items. Tap **Folder Options** to open and modify the settings for that folder.

Text (SMS) messages

You can use your smartphone to send and receive text messages to other mobile phones. Each text message can contain up to 160 characters.

Creating and sending text messages

1. Tap **Text** (). Then tap the drop-down menu in the top left corner of the messaging screen.
2. Tap the **Messages** folder and the Inbox appears.
3. Tap **Menu > New > Text Message**. The message composition window appears.
4. Enter a recipient, enter your message and then tap **Send**.



.....
Tip: You can request delivery notification to ensure that your message has reached its recipient. To do this, tap **Menu > Tools > Options > Accounts** tab from the Text Messages folder. Tap *** Messages** and check the **Request delivery notifications** checkbox.
.....

Replying to text messages

When a new text message arrives a message icon appears at the top of the screen and a notification message is displayed.

1. Tap **Text** () to view your inbox.
2. Tap a message to open it.
3. Tap **Reply** to reply to the message and the message composition window appears.
4. Enter your text and tap **Send**.

Sorting text messages

You can sort your text messages by message type, sender, received messages and message subject.

Tap the **Sort by** drop-down menu in the top-right of the messaging screen, and select an option from the list.

MMS messages

MMS messages are similar to text messages but also allow you to attach multimedia files such as pictures, audio or video clips. Each MMS message can be up to 300 kB in size.

Setting up MMS messaging

Before you can send MMS messages, you have to set up a connection and profile. Ask your network provider for the information required to complete the setup procedure.

1. Tap **Start > Settings > Connections > Connections**.
2. Tap **Add a new modem connection** section.
3. The **Make New Connection** screen appears.
4. Enter a name for the connection.

5. Select **Cellular Line (GPRS)** from the **Select a modem** list and tap **Next**.
6. Enter the access point name provided by your network provider.
7. Enter your user name, password and domain.
8. Tap **Finish** to save and complete setup.

Setting up MMS profiles

You can select and configure several MMS messaging profiles for different networks and environments.

1. Tap **Text** () , then tap the drop-down menu in the top left corner of the messaging screen.
2. Tap the **Messages** folder and the Inbox appears.
3. Tap **Menu > MMS Settings > MMS Profiles** tab.
4. Tap a profile from the list. Tap **Edit** to view the selected profile settings.
5. Tap each field to adjust its setting. These fields should be automatically configured by your network provider. If so, we recommend you leave them as they are.
6. Tap **Done** once you have finished editing the profile.
7. Tap **Select** to select the profile from the list and tap **OK**.



.....
Note: For further information on options available to you when editing or creating MMS profiles, refer to the Help menus.
.....

Creating MMS messages

1. Tap **Text** () , then tap the drop-down menu in the top left corner of the messaging screen.
2. Tap the **Messages** folder and the Inbox appears.

3. Tap **Menu > New > Multimedia Message** and the message composition window appears.
4. Enter the recipient (along with other recipients in the Cc and Bcc fields if necessary) and subject of the MMS.
5. To attach a picture or video clip, tap **Insert Picture/Video** () and select the file you want to attach.
6. To attach an audio file, tap **Insert Audio** and select the file you want to attach. The audio file will be displayed in the message.
7. To insert text, tap **Insert Text** and enter your message. All attachments and text will now be displayed in the message window.
8. Tap **Send**.

Replying to MMS messages

When a new MMS message arrives, a message icon appears at the top of the Today screen and a notification message is displayed.

1. Tap **Text** () , then tap the drop-down menu in the top left corner of the messaging screen.
2. Tap the **Messages** folder and the Inbox appears.
3. Tap a message to open it.
4. Tap **Menu > Reply** to reply to the message. The message window will appear.
5. Follow the steps described in **“Creating MMS messages” on page 34** to compose your reply.
6. Tap **Send**.

Sorting MMS messages

You can sort your MMS messages by message type, sender, received messages and message subject.

Tap the **Sort by** drop-down menu in the top-right of the messaging screen, and select an option from the list.



Note: For further information on options available to you when creating, replying to and sorting SMS and MMS messages, refer to the Help menus.

Email

Your smartphone uses Outlook Mobile to manage email accounts. Tap **Start > E-mail** to access the account setup. Tap **Setup E-mail** to set up your email account.



Enter your email address and password to set up the account. Select if you want to save your password or not.

When you've finished entering the information, tap **Next**. Your smartphone has pre-set definitions for a variety of popular ISPs and will recommend settings if your email address is recognized. Otherwise your smartphone will try to connect to the Internet to find the settings.

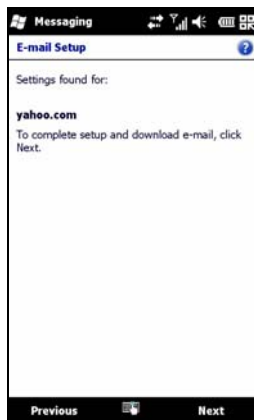

Chapter 5: Using the Camera











Your smartphone features a 5-megapixel digital camera mounted on the rear. This section will take you through all the steps in taking photos and videos with your smartphone.

To activate the camera, press the camera button.

Camera icons and indicators



Icon	Description
	Adjust the camera mode. <ul style="list-style-type: none">• Photo - Take a photograph.• Video - Shoot a video.• Continuous 3/5/9 - Take three, five or nine photos in a burst (select the number of photos by tapping the icon repeatedly).• Anti-shaking• POI Photo• MMS

Icon	Description
	Adjust the camera focus mode. <ul style="list-style-type: none"> Central Focus - Focus on the item in the center of the frame.
	Adjust the image resolution.
	Apply an effect to photos taken: <ul style="list-style-type: none"> Normal - No effect is applied. Greyscale - Takes black and white photos. Negative - Uses negative colors when taking the photo. Sepia - The photo is given a Sepia appearance. Solarize - The photo is solarized
	Enter the advanced settings page.
	Exit and return to the previous screen.
	Set the white-balance mode.
	Turn the flash on or off.
	Open the album to view thumbnails of stored pictures and videos.
	Displays the storage being used and approximately how many photos you can still take.
	Displays the battery charge status.
	Displays the current magnification.

Taking a photo

1. Frame your subject and steady your smartphone.
2. Adjust any settings you require, such as brightness and scene mode. To zoom in or out, press the (+/-) volume keys.

3. Press the camera button down halfway until the image comes into focus. Push down fully to take the photo.

Shooting a video

1. Frame your subject and steady your smartphone.
2. Press the camera button down fully to begin recording.
3. Press the camera button down fully to stop recording.

Supported formats

The following file formats are supported:

Type	Formats
Image	JPEG
Video	MP4

Save photos and videos to a micro SD card

Tap **Start** > **File Explorer** > **My Documents** > **My Pictures** (or **My Videos**). Tap and hold on the file you want to save to your micro SD card, select **Copy** or **Cut** from the pop-up menu.

Navigate to your microSD card in **File Explorer**, tap and hold in the folder you want to save the image/video to, and select **Paste** from the pop-up menu.



Tip: Use the Advanced Settings screen in Camera to set the storage to the microSD card so you can easily transfer pictures to your computer.

Photo and video options

After you have taken your photo or video, it is automatically saved.



Note: The default locations for saving photos and videos are My Documents/My Pictures and My Documents/My Videos respectively. This can be changed from the Settings page.

Tap the Album icon and select a photo to view. Tap the photo to display the option icons.

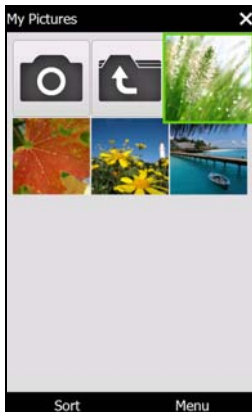

From this interface, you can start a slideshow with all the pictures in the folder, send the current picture to a contact as an MMS or email message, view the picture's information, delete the picture or return to the thumbnail view.

You can also zoom into the picture or zoom out and navigate to the previous or following file.

Editing photos

You can crop or rotate your saved photos.

1. Tap **Start > Multimedia > Pictures & Videos**.
2. All your photos and videos are displayed as thumbnails. Select a photo to edit.
3. Tap **Menu** to view the list of editing options.

Chapter 6: Advanced Operation

Putting your smartphone in flight mode

You can enter flight mode to turn off telephone, Bluetooth and WLAN functions and use the smartphone as a handheld device during a flight. Check with your airline to make sure this is permitted onboard.

Some airlines may provide wireless Internet services on board that can be accessed via the WLAN feature. Check prior to your departure whether this service is available on your flight.

Switch your smartphone off during takeoff and landing as it may interfere with aircraft electronic systems.

Entering flight mode

1. Access the Comm. Manager (refer to **“Comm. Manager”** on page 45).
2. Tap Flight Mode **ON** to turn off all phone, Bluetooth and WLAN functions.

Comm. Manager

Your smartphone features phone, Bluetooth and WLAN functions. This section will explain how to activate and set basic phone, Bluetooth and



wireless network (WLAN) connection settings through the Comm. Manager screen.



Tip: Tap and hold the name of any communication type to open its associated Settings page.

Using the Comm. Manager

To access the Comm. Manager, tap any of the communication icons at the top of the screen or **Start > Settings > Connections > Comm. Manager**.

Activating or deactivating connections

You can choose to activate one or all connections from the Comm. Manager window.

Each connection icon will be highlighted when turned on.

Adjusting connection settings

This section will show you how to adjust detailed settings for your phone, wireless and Bluetooth connections.

Phone connections

Once you have inserted a SIM card, the smartphone will automatically detect your network provider.

For all phone settings, tap **Start > Settings > Personal > Phone**. Here you can adjust ringtone, security, services, network and CB (Cell Broadcast) settings.

Adjusting phone connection settings

You can use the Connection Wizard to configure country and network settings for your phone connection, as well as create customized phone connections.

1. Tap **Start** > **Settings** > **Connections** > **Connection Wizard**.
2. Select your country and network operator from the lists.
3. Tap **OK** to confirm and save.

To detect these settings automatically, tap **Search**.

To edit network parameters, tap **Edit**.

Once all settings are complete, tap **OK** to confirm and save.

Creating and editing new phone connections

If your country is not listed, or you want to create a customized GPRS or CSD connection, refer to 'Creating a new connection' in the Phone Data Manager Help menus for detailed information on how to do this.

Selecting a network

You can set the smartphone to detect your network automatically or set it manually.

Detecting a network automatically

1. Tap **Start** > **Settings** > **Personal** > **Phone** > **Network** tab.
2. Select **Automatic** from the **Network Selection** list.
3. Tap **Find Network**. Your network will be automatically detected.

Selecting a network manually

1. Tap **Start** > **Settings** > **Personal** > **Phone** > **Network** tab.
2. Select **Manual** from the **Network Selection** list. A list of available networks will appear.
3. Select a network from the list and tap **OK**.

When your current network is unavailable, tap **Select** to select another network to use.



.....
Note: Contact your service provider should you have any problems obtaining voice mail and the text message service center numbers.
.....

Adjusting wireless network settings

You can use your smartphone to connect to a wireless local area network (WLAN) to exchange information with your PC or network and access the Internet.

If there are multiple WLANs available, your smartphone will prompt you to choose a network when you activate the WLAN function. Select a network and specify whether it will be used primarily for **Work** or **The Internet**. The smartphone will save your settings and connect to your chosen network.

Wireless power management

When activated, wireless connections use considerable battery power so we recommend customizing power management options to get the most out of your battery.



.....
Note: When battery power is lower than 20 percent, a notification message will appear asking if you want to continue using wireless functions or not.
.....

You can create, view and edit all available wireless networks in your area, and configure network adapter card settings.

Viewing wireless networks

1. Tap **Start > Settings > Connections > Wi-Fi > Wireless** tab.
2. Scroll through the list to view all available networks.
3. Tap the **Networks to access** list to sort by **All available**, **Only access points** or **Only computer-to-computer** connections.

Creating new wireless network connections

1. Tap the **Start > Settings > Connections > Wi-Fi > Wireless** tab.
2. Tap **Menu > Add New...** from the list.
3. Enter all required information to configure the wireless network. Refer to the Help menus to guide you through the configuration screens for each setting.

Editing wireless network connections

1. Tap the **Start > Settings > Connections > Wi-Fi > Wireless** tab.
2. Select a connection from the list.
3. Tap **Menu > Edit**.
4. Enter all required information to configure the wireless network. Refer to the Help menus to guide you through the configuration screens for each setting.

Adjusting network adapter settings

1. Tap **Start > Settings > Connections > Wi-Fi > Network Adapters** tab.
2. Select a network adapter from the list.
3. Tap **Edit**.
4. Select to use a server-assigned IP address or enter a specific IP address.
5. Tap **OK** to confirm and save.

Adjusting Bluetooth settings

You can use Bluetooth to exchange information between your smartphone and other mobile devices.

Bluetooth connections

For all Bluetooth settings, tap **Start > Settings > Bluetooth**. Here you can adjust Bluetooth profiles, status, accessibility, and services settings. You can also view version information.

Creating new Bluetooth connections

The simplest way to set up and configure a new Bluetooth connection is through the Bluetooth Manager.

1. Tap **Start > Settings > Bluetooth**. You will be asked to turn on Bluetooth, then tap **Settings > Add a device**.
2. Alternatively tap **Start > Settings > Bluetooth > My Devices > Add**.
3. Your smartphone will search for devices in range.
4. Select the device you want to connect to.
5. Tap **Select** and follow all onscreen instructions to set up the connection.

Adjusting Bluetooth settings

1. Tap the **Start > Settings > Bluetooth > Settings**.
2. Select whether to **Enable** or **Disable** the Bluetooth function and whether the device should be **Discoverable** or not.
3. You can also define a **Name** for your smartphone.
4. Tap **Advanced...** to change additional **Connectivity, Serial Ports, File Transfer, Audio, Object Exchange, Synchronization** and **SIM Accessories**.

Phone settings

Many phone settings are automatically configured by your smartphone when you insert a SIM card. The device will communicate with your service provider and automatically obtain all necessary settings, such as network name, voice mail and text message center numbers.

You can, however, view and modify these settings yourself if necessary, through the Phone Settings screen.

Tap **Start > Settings > Personal > Phone**.

Configuring caller options

You can configure certain caller options to keep control over your incoming and outgoing calls.

Bar outgoing or incoming calls using call barring; choose who to display your identity to with caller ID; specify a number to which calls can be forwarded if you are unavailable using call forwarding; choose to be notified if an incoming call is waiting using call waiting.

Setting up caller ID

1. Tap **Start > Settings > Personal > Phone > Services** tab.
2. Select **Caller ID** from the list and tap **Get Settings**.
3. Select who to provide your caller ID to.
4. Tap **OK** to confirm and save.

Setting up call forwarding

1. Tap **Start > Settings > Personal > Phone > Services** tab.
2. Select **Call Forwarding** from the list and tap **Get Settings**.
3. Specify whether to forward all calls or only under certain conditions. Tap the checkboxes to select the option you require and enter number(s) to which the calls will be forwarded.
4. Tap **OK** to confirm and save.

Setting up call waiting

1. Tap **Start > Settings > Personal > Phone > Services** tab.
2. Select **Call Waiting** from the list and tap **Get Settings**.
3. Select whether to be notified or not when a call is waiting.

4. Tap **OK** to confirm and save.



Note: Refer to the Help menus for more detailed information on adjusting phone settings.

Managing your phonebook

Your smartphone features an address book that allows you to save contacts to either the internal memory or onto your SIM card.

Adding and editing contacts

To add a new contact:

1. Enter the telephone number with the onscreen number pad.
2. The phone will recognize a new number. Select **Save as a new contact**.
3. Select whether this is a **SIM Contact** or **Phone Contact**.
4. Enter the required information.
5. Tap **Save**.

You can choose to save contacts directly to your SIM card. This is useful if you use your SIM card with multiple phones and you always need your address book to hand.



Note: You can only enter a contact name and telephone number when creating a new SIM contact. If more information is required, create a regular phone contact.

Editing a contact

1. Tap **Phonebook** from the Today screen or **Start > Phonebook**.
2. Select and open the contact you want to edit.

3. Tap **Menu > Edit this contact**.
4. Edit the contact information and tap **Save**.

Copying contacts

You can copy contacts stored in internal memory to your SIM card, and vice versa.

Copying a contact from internal memory to the SIM card



.....
Note: Copying a contact from internal memory to your SIM will only copy the contact's name and phone number. Names longer than 14 characters will be truncated.
.....

1. Tap **Phonebook** from the Today screen or **Start > Phonebook**.
2. Select the contact you want to copy by using the up and down navigation buttons.
3. Tap **Menu > Copy to SIM**.

Copying a contact from the SIM card to internal memory

1. Tap **Phonebook** from the Today screen or **Start > Phonebook**.
2. Select the contact you want to copy by using the up and down navigation buttons.
3. Tap **Menu > Copy to Phone**.

Sending contacts via text

You can send your contacts details to other phones using text messaging or via beam.

Sending contacts via message

1. Tap **Start > Contacts**.
2. Select a contact.
3. Tap **Menu > Send Contact > Messages**.
4. Select the contact information you want to send and tap **Done**.
5. Specify a recipient and tap **Send**.

Deleting contacts

To free up space on either the internal memory or on your SIM card, you can delete contacts from your address book.

1. Tap **Phonebook** from the Today screen or **Start > Phonebook**.
2. Select the contact you want to delete.
3. Tap **Menu > Delete Contact**.
4. Tap **Yes** to permanently delete the contact.

Assigning a ring tone and picture to specific contacts in your phone

You can assign a specific ringtone and picture to a particular phone contact so they are easily identifiable when they call.

1. Tap **Phonebook** from the Today screen or **Start > Phonebook**.
2. Tap on the contact you wish to assign a ringtone/picture to.
3. Tap **Menu > Edit this contact**.
4. Tap **New pictures** to open My Pictures. Tap the desired picture to assign a picture to the contact.
5. Tap **More** to view more options.
6. Tap **Ringtone** and select a ringtone from the list.

SIM Manager

SIM Manager allows you to manage your SIM phonebook and to copy the phonebook entries to Contacts. To start SIM Manager, tap **Start > Utilities > SIM Manager**.

The standard display mode is to show your SIM contacts and Contacts entries at the same time. You may change this by tapping **SIM**, **Contact** or **Standard** at the bottom of the screen.

You can sort your contacts by tapping **Name** or **Pos** (only for SIM contacts) at the top of the list of contacts.

In the SIM phonebook, tap and hold on a contact to **Dial** that contact's number, **Send SMS**, **Edit**, **Delete** or **Copy to Contact**.

In the Contact list, tap and hold on a contact to **Dial** that contact's number or **Copy to SIM**.

Tap **Menu** at the bottom of the screen to reveal:

New SIM Contact: Add a new phonebook entry to the SIM card.

Refresh: Refresh the contact lists.

SIM Information: View your SIM card information.

My Phone Numbers: Displays the information of the inserted SIM card

About: View the version and copyright information of SIM Manager.

Copying contact information

You can copy contact information to/from the Contacts list from/to the SIM card. You may copy individual contacts, multiple contacts or all contacts.

- To copy all contacts, tap the box alongside Name: Tap and hold any contact and select **Copy to Contact/SIM**.

- To copy multiple contacts, tap the box alongside each contact: Tap and hold any contact and select **Copy to Contact/SIM**.
- To copy a single contact, tap and hold any contact, and select **Copy to Contact/SIM**.

Connecting to a PC and synchronizing

You can use Microsoft ActiveSync (on Windows XP) or the Windows Mobile Device Center (on Windows Vista and Windows 7) to synchronize the information on your computer with the information on your smartphone, comparing and updating data on both locations. This serves as backup data in case something happens to your smartphone.

Connecting to a PC

The packaged mini USB sync cable enables you to synchronize the information on your smartphone with the data on your computer using Windows Mobile Device Center, Windows Sync Center or ActiveSync.

Plug the mini USB sync cable into the mini USB connector on your smartphone. Plug the USB client connector into an available USB port on your computer.

After a short delay, your smartphone should be recognised and the program to synchronize your smartphone files will open. Please check the help files for the program installed on your computer for more information.

Configuring USB to PC settings

You can enable advanced networking to enhance your USB to PC connection, should you be experiencing any problems synchronizing your data with ActiveSync.

1. Tap **Start > Settings > Connections > USB to PC**.
2. Check the **Enable advanced network functionality** checkbox to enable.
3. Tap **OK** to confirm and save.

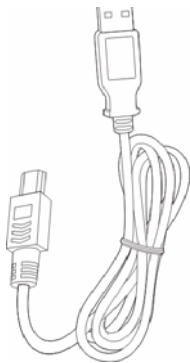

Other functions

Managing your agenda

You can set appointments and anniversary reminders with the agenda feature.

Setting a new appointment

1. Tap **Start > Agenda**.
2. Tap **Add an agenda entry**.
3. Enter appointment information and recurrence frequency.
4. Tap **OK** to confirm and save.

To edit an appointment, tap the entry to edit the appointment.

Creating tasks

Tasks can be set to remind you of specific things you must do and the completion deadlines.

Creating a new task

1. Tap **Start > Tasks**.
2. Tap **Menu > New Task**.
3. Enter all task information, start and due dates and how often to be reminded.
4. Tap **OK** to confirm and save.

To edit a task, tap the entry and then tap **Menu > Edit** to open the task entry screen.





.....
Note: For more information on other options available in the agenda and task screens, refer to the Help menus.
.....

Browsing the Internet

In order to browse the Internet with your smartphone, you must be connected to a 3G or wireless network or to a computer with an Internet connection via ActiveSync.

Tap **Start > Internet Explorer** to open the browser.

To adjust your browser settings, tap  >  > **Tools > Options**.

Starting Windows Live

1. Tap **Start > Windows Live**.
2. Sign in with your email address and password and your contacts list appears.

Multimedia playback

Your smartphone comes supplied with a variety of programs that you can use to enjoy multimedia content.

FM Tuner

FM Tuner allows you to listen to your favorite local radio stations and save them to an easily-accessible list of favorites.

To start FM Tuner tap **Start > Multimedia > FM Tuner**.



Note: You will need to connect your headset to enjoy radio programs.

The FM Tuner screen indicates the frequency the tuner is receiving (1), volume level (2) and your defined favorites (3).

Tap the frequency display to open a number pad that allows you to enter a different frequency.

Tap **My Favorite** to manage your list of favorite radio stations. To add a favorite, select the position in the list that you'd like to add the favorite at, and tap  to open



the frequency allocation window. Enter the frequency using the keyboard.



Important: There are restrictions on the range of frequencies that may be legally listened to in many countries. The FM Tuner on your smartphone has three predefined geographical regions: EUROPE, JAPAN and USA. You may only set a frequency within the range specified for each region.

Media Player

Tap the Media player icon on the Today screen, or **Start > Multimedia > Windows Media**. The Media Player will search for all supported media files on your smartphone. Tap the **Play** icon to start playback immediately.

Tap **Sort By** to sort your media files according to Album, Artist, Genre, Folder or Favorites.

Using Windows Media Player

You can use Windows Media Player to play videos you have taken with your smartphone as well as other media files, such as MP3 music files.

The following formats are supported:

Type	Formats
Audio	WMA, MP3, WAV, AAC
Video	WMV

Playing video or audio files

1. Tap **Start > File Explorer**.
2. Locate the file to playback, and tap once to play it in Windows Media Player.

Streaming Media

Streaming Media allows you to view streamed video off the Internet directly on your phone.

If you try to open an audio or movie video that is not supported by Microsoft Windows Media Player, for example RTSP or HTTP, the system will automatically switch to Streaming Media.

Alternatively tap **Start > Multimedia > Streaming Media** to manually launch the player. You can enter the address of the content you wish to access in the address bar.

Tap anywhere on the playback window to display the content full-screen. Tap the screen again to return to the normal display mode.



Satellite Data Update



Warning: Satellite Data Update is not supported in the USA.

Tap **Start** > **Utilities** > **Satellite Data Update**.

You may need to log into your provider's server to download instant satellite data and enable the GPS function.



Note: All the following connections allow your smartphone to download the latest GPS data. If there is more than one connection available, the system will automatically select the best connection, in the following order: Sync connection to PC; WLAN; GPRS (not supported when roaming).

The system will update GPS data automatically based on a schedule.

Check the automatic update checkbox.

Set the date and time.

You will see the expiration date of the GPS data. On the due date, a warning message will appear to remind you.

Alternatively, tap **Download** to update the GPS data manually.



Important: You may be charged additional fees when connecting over GPRS.

Personalizing your smartphone

You can enter your personal information to easily identify your smartphone. This is especially useful if it should ever be lost or stolen. To enter owner information, tap **Start > Settings > Personal > Owner Information**.

Enter your name along with any other information you want to store.

Tap the **Notes** tab to add any additional notes.

Tap the **Options** tab to configure how this information is displayed.

Tap **OK** to confirm and save.



Naming your smartphone

Your smartphone uses a name to identify itself when connected to other computers. To specify a name, tap **Start > Settings > System > About > Device ID** tab.

Enter a name for your device. Add a description if necessary.

Tap **OK** to confirm and save.



The application button

Your smartphone has three default application buttons set to run the following:

Button 1 - Today

Button 2 - OK/Close

Button 3 - Camera

We recommend that you use this default whenever possible.



Tip: The application buttons can be configured to launch applications that you use the most.

To configure which applications to launch with each button, tap **Start > Settings > Personal > Buttons**.

Select the button you wish to configure from the list, then select the program to assign to the button from the drop-down list below.

Tap **OK** to confirm and save.

As the buttons have icons printed on them, Acer strongly recommends retaining the default settings. This avoids confusion when using your smartphone.



Adjusting the volume



To adjust the volume, tap  at the top of the screen. The volume control appears.

- Use the right slider to adjust the ring volume.
- Use the left slider to adjust system volume.
- Use the icons at the top of the screen to turn all sounds on, set to vibrate only or mute all sounds.

- If you adjust the volume during a call, the speaker volume will be adjusted.

Configuring shortcut programs

You can select the programs you most frequently use and put them in the Today screen as shortcuts.

1. Tap  to bring up the edit screen.
2. Select the programs that you want to appear in the Today screen from the list.
3. Tap **Save**  to confirm and save.

Configuring sounds and notifications

You can specify sounds to play for certain events or when certain actions are performed.

1. Tap **Start > Settings > Sounds & Notifications > Sounds** tab.
2. Select to enable sounds for events or programs. You can also specify to enable sounds when tapping the screen or pressing buttons.
3. Tap the **Notifications** tab.
4. Select an event from the list and the notification options for that event are displayed.
5. Adjust the settings.
6. Repeat steps 4 and 5 to adjust notification options for other events.
7. Tap **OK** to confirm and save.

Configuring backlight settings

You can specify the appearance and conditions under which the screen backlight will be on or off.

1. Tap **Start > Settings > System > Backlight > Battery Power** tab.

2. Select the timing for the backlight to turn on and off when your smartphone is running on battery power.
3. Tap the **External Power** tab. Select the timing of the backlight to turn on or off when your smartphone is running on external power.
4. Tap the **Backlight Level** tab. Adjust the backlight brightness level and automatic level selection options.
5. Tap **OK** to confirm and save.



Tip: Backlight settings greatly affect battery life. Configure these settings carefully to ensure that you get the most out of your battery.

Managing system certificates

System certificates are used to positively identify your smartphone to other systems.

Tap **Start > Settings > System > Certificates** to view all certificates.

Setting the date and time

To set the date and time, tap **Start > Settings > Clock & Alarms > Time** tab.

Select your time zone from the drop-down menu. Set the time by tapping the up and down arrows. Select the date from the drop-down calendar.

Tap **OK** when you have finished.

Setting alarms

1. Tap **Start > Settings > Clock & Alarms > Alarms** tab.
2. Tap the checkbox to activate an alarm.
3. Tap **Description** and enter a name for the alarm.



4. Select the day and time for the alarm.
5. Tap **OK** to confirm and save.

Configuring regional settings

You can adjust regional settings for number, currency, date and time formats to match those used in your country.

1. Tap **Start > Settings > System > Regional Settings**.
2. Tap the **Region, Number, Currency, Date** and **Time** tabs to view information for your region. Adjust any if necessary.
3. Tap **OK** to confirm and save.

Power saving options

1. Tap **Start > Settings > System > Power > Advanced** tab.
2. Select the interval after which your smartphone will turn off if not in use. You can specify two intervals: one for when on battery power, and one for when on external power.

Viewing power status

Tap **Start > Settings > System > Power > Battery** tab to view battery power status.

Removing programs

You can remove programs you have installed on your smartphone to free up extra storage memory.



.....
Note: You can only remove programs you have installed, you cannot remove programs installed during manufacture.
.....

1. Tap **Start > Settings > System** tab > **Remove Programs**.
2. Tap the program you want to remove from the list.
3. Tap **Remove** and the program will be uninstalled.

Configuring screen options

You can change orientation, align the screen, enable ClearType and adjust text size to make viewing your smartphone as comfortable as possible.

1. Tap **Start > Settings > System > Screen > General** tab.
2. Select screen orientation and tap **Align Screen** if you need to re-align the screen.
3. Tap the **ClearType** tab. Select to enable ClearType.
4. Tap the **Text Size** tab. Move the slider to adjust text size.
5. Tap **OK** to confirm and save.

Updating your smartphone

You may use the Notification Manager to check for updates for your smartphone's software.

1. Tap **Start > Notification Manager**.
2. Tap **Check now** to see if an update is available.



Important: You may be charged additional fees when connecting over GPRS.

If updates are available, brief information about each update will be displayed. Tap an update to see download options. Some updates may be downloaded directly to your smartphone, others must be run from a computer.

Tap **Generate URL** to create a download link. You may then transfer this link to your PC in order to download and run the update. See **"Connecting to a PC"** on page 56.

The link may be found in the **My Documents** folder. Tap **Start > File Explorer > NotificationManager**. You may transfer this shortcut to your computer and use your computer's internet

connection to download the update. Install this update correctly by following the instructions provided with the files.

Setting a schedule

It is also possible to set schedule to check for updates.

1. Tap **Menu**, then Settings.
2. Enable the scheduled notification update and set either a daily or weekly check.
3. Tap **OK** to confirm and save.

Resetting your smartphone

You may have to perform a reset if your smartphone fails to respond when buttons are pressed or the screen is tapped.



.....
Note: Before performing a reset, ensure that your smartphone is not locked. Press any key or tap the screen to see if the phone responds.
.....

Reset

A reset will clear the RAM of your smartphone. It is similar to turning a computer off and then turning it back on.



.....
Important: To reduce risking damage to your smartphone, only use the supplied stylus to reset the device.
.....

Use the tip of your stylus to lightly press the **Reset** button inside the hole on the side of your smartphone.

Clean boot



.....
Warning! You should only perform a clean boot when all other reset options have failed to restore your smartphone to an operational state.
.....

A clean boot will restore your smartphone to the state it was when you got it from the factory.



.....
Warning! This will erase all your personal information, any contacts stored on your smartphone and any programs you installed.
.....

If your screen is responding to stylus input: Go to **Start > Utilities > Default Settings**. Read the warning information and enter the security code in the empty textbox. Tap **OK** to proceed.

If your screen is not responding to stylus input: Hold the Volume up and Volume down buttons while pressing reset until the screen shows "Clean Boot".

Chapter 7: Accessories and Tips

This chapter shows you how to use accessories with your smartphone, as well as provide useful tips for when you are using your smartphone.

Using the headset

Your smartphone comes packaged with a 3.5 mm headset with built-in microphone for handsfree use when making calls.

To use the headset, plug it into the 3.5 mm jack on the top of the smartphone.

When the headset is plugged in, all audio is routed to the headset, and the speakers are turned off.

- To answer an incoming call, press the button on the microphone.
- Adjust the volume using the volume up/down button on the smartphone.
- End the call by pressing the button on the microphone again.

Using a Bluetooth headset

Your smartphone Bluetooth functions make it fully compatible with all Bluetooth headsets. This allows you to use the unit handsfree when making calls, without the inconvenience of wires.

To set up your Bluetooth headset:

1. Turn on Bluetooth using the Comm. Manager (please see **“Comm. Manager” on page 45**).

2. Connect to the headset as described in **“Creating new Bluetooth connections” on page 50.**
3. Tap the icon for your Bluetooth headset.
4. Enter your headset passkey and tap **OK.**
5. Tap **Finish** to complete setup.

When you want to answer an incoming call, press the

“answer” button on your Bluetooth headset. Press  to end the call.



Tip: As well as being essential for handsfree operation when driving, you can also use your Bluetooth headset when at home or in the office, to avoid carrying your smartphone around with you at all times. In ideal conditions, Bluetooth range is up to 10 metres, or 30 feet.

Using your smartphone as a modem

When connected to your PC, your smartphone can function as a modem via GPRS or UMTS.

You can also use a USB connection or the Bluetooth function of your smartphone to connect to your PC or laptop and act as a modem. You must first set up an ISP connection on your PC or laptop.

1. Click **Start > Settings > Control Panel.**
2. Click **Network Connections > Create a new connection.**
3. Click **Next** to begin the New Connection Wizard.
4. Select **Connect to the Internet** and click **Next.**
5. Select **Set up my connection manually** and click **Next.**
6. Select **Connect to a dial-up modem** and click **Next.**
7. Enter the name of your ISP (Internet Service Provider) and click **Next.**

8. Enter your ISP's phone number. The number must begin with '*99#'. Click **Next**.
9. Select one option from the Connection Availability screen and click **Next**.
10. Enter your username and password and click **Next**.
11. Click **Finish** to complete the setup.

You can now establish a Bluetooth connection between your PC and your smartphone. When you attempt to access the Internet on your PC, the smartphone will dial the ISP number specified to establish a connection.

Using a USB connection

1. Close ActiveSync if it is running. This helps Internet sharing to function properly.
2. Tap **Start > Programs > Internet Sharing**.
3. Select USB from the PC connection drop-down menu.
4. Select your network connection type from the network connection drop-down menu.
5. Tap **Connect**.

Your Acer S200 Smartphone will now act as a modem.

Using a Bluetooth connection

You can also use Bluetooth to link your PC to your smartphone to connect to the Internet. Ensure that Bluetooth is enabled from the Comm. Manager (refer to "**Comm. Manager**" on **page 45**), and that other devices can discover your smartphone. To do this, open the Comm. Manager, tap **Settings > Bluetooth > Mode** tab, and check **Make this device visible to other devices**.

Ensure that your computer's Bluetooth adapter is switched on.

- Open **Bluetooth Places** and click **Add...**, then follow the steps of the Add Bluetooth Device Wizard.

- Double click on your smartphone device name.

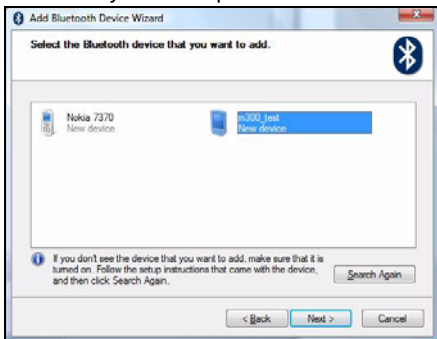

- Select **Let me choose my own passkey** when requested, and enter a passkey.

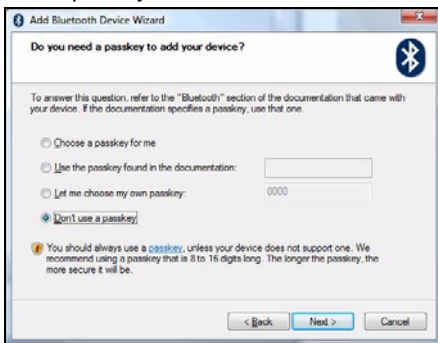

- Your smartphone will ask to allow pairing, and for the Passkey. Enter the same code you entered above and tap **OK**.

- Windows will automatically connect to your smartphone and detect what services are available.

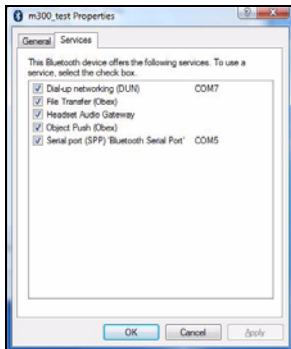

Inserting a microSD card

Your smartphone features a memory expansion slot that accepts a micro SD card to expand memory and storage capacity.

Please refer to **“Installing a SIM card or microSD card”** on page 14 for proper instructions on installing a microSD card.

Appendix

FAQ, troubleshooting and error messages

This section lists frequently asked questions that may arise during the use of your smartphone, and gives easy answers and solutions to these questions.

Aspect	Question	Answer
Audio	Why is there no sound coming from the device?	<p>If the headset is plugged into the device, the speaker is automatically shut off. Disconnect the headset.</p> <p>Check that the device volume setting is not muted. Tap any two communication icons at the top of the screen.</p> <p>Check that the volume control is not at its lowest setting.</p>
Multimedia files	Why can't I view my picture files?	You may be trying to view an image that is not supported. Refer to "Multimedia" on page 79 for more information.
	Why can't I view my video files?	You may be trying to view a video that is not supported. Refer to "Multimedia" on page 79 for more information.
	Why can't I play my music files?	You may be trying to play a file that is not supported. Refer to "Multimedia" on page 79 for more information.

Aspect	Question	Answer
System information and performance	How do I check the OS version of my device?	Tap Menu > Settings > About phone to check the OS version (Kernel/build number) and other hardware and software information.
Power	I couldn't turn on the device.	The battery power may be depleted. Recharge the device. Refer to " Charging the battery " on page 13 for more information.

Error messages

Error message	Description
Connection canceled	Operation canceled by the user.
Service unavailable - please try again later	The network is not stable, or server has not responded. Try again later.
Connection unavailable - please check your network settings	<p>No path to the destination is available. Please check the settings in Start > Settings > Connections.</p> <ol style="list-style-type: none"> If your Smartphone is connected to your PC via USB, check both the PC's network settings and ActiveSync settings (when connected via USB, GPRS/3G is not used). <p>Notes:</p> <ol style="list-style-type: none"> Try using Internet Explorer to connect to a website to verify your network connection.

Specifications

Performance

- Qualcomm 8250, 1 GHz
- System memory:
 - 256 MB of SDRAM
 - 512 MB of Flash ROM
- Windows Mobile 6.5 Professional

Display

- 3.8" WVGA TFT-LCD touchscreen
- 480 x 800 resolution
- 262K color support

Multimedia

- CD-quality stereo output
- Mini USB microphone input
- Mono speaker 0.5 W (max)
- Omni-directional microphone
- Formats supported

Type	Formats
Audio playback	MP3, AAC, AMR
Ringtone	SP-MIDI, MIDI, MMF, AMR, MP3, AAC
Video recording	3GP, MPEG-4, H.263, AVI
Video playback	3GP, MPEG-4, H.263, H.264

USB connector

- 10-pin mini USB connector

- USB Client
- DC power-in (5 V, 1 A)

Connectivity

- Bluetooth 2.1+EDR
- IEEE Wi-Fi 802.11 b/g WLAN
- GSM 850 / 900 / 1800 / 1900
- UMTS 900 / 1900 / 2100
- HSDPA / HSUPA / EDGE / GPRS

Camera

- 5-megapixel
- Auto-focus

Expansion

- MicroSD memory card support
- SDHC support

Battery

- High density, rechargeable 1350 mAh Lithium Polymer battery (replaceable)



.....
Note: Length of battery operation will depend on power consumption which is based on system resource use. For example, constantly using the backlight or using power-demanding applications will shorten battery life between charges.
.....

Dimensions

- Stylish, light and robust design

Height	118.6 mm
Width	63 mm

Thickness	12 mm
Weight	130 g (with battery)

Warnings and precautions

- Do not use this product near water.
- Do not place this product on an unstable cart, stand or table. If the product falls, it could be seriously damaged.
- Slots and openings are provided for ventilation to ensure reliable operation of the product and to protect it from overheating. These openings must not be blocked or covered. The openings should never be blocked by placing the product on a bed, sofa, rug or other similar surface. This product should never be placed near or over a radiator or heat register, or in a built-in installation unless proper ventilation is provided.
- Never push objects of any kind into this product through cabinet slots as they may touch dangerous voltage points or short-out parts that could result in a fire or electric shock. Never spill liquid of any kind onto or into the product.
- To avoid damage of internal components and to prevent battery leakage, do not place the product on a vibrating surface.
- Never use this product when engaging in sporting activities, exercising, or in any vibrating environment which may cause a short circuit or damage, and even a risk of explosion from the battery pack.

CAUTION when listening to music

To protect your hearing, follow these instructions.

- Increase the volume gradually until you can hear clearly and comfortably.
- Do not increase the volume level after your ears have adjusted.

- Do not listen to music at high volumes for extended periods.
- Do not increase the volume to block out noisy surroundings.
- Decrease the volume if you can't hear people speaking near you.

Battery information

This product uses a Lithium Polymer battery. Do not use it in a humid, wet and/or corrosive environment. Do not put, store or leave your product in or near a heat source, in a high temperature location, in strong direct sunlight, in a microwave oven or in a pressurized container, and do not expose it to temperatures over 60 °C (140 °F). Failure to follow these guidelines may cause the battery to leak acid, become hot, explode or ignite and cause injury and/or damage. Do not pierce, open or disassemble the battery. If the battery leaks and you come into contact with the leaked fluids, rinse thoroughly with water and seek medical attention immediately. For safety reasons, and to prolong the lifetime of the battery, charging will not occur at low (below 0 °C/32 °F) or high (over 40 °C/104 °F) temperatures.

The full performance of a new battery is achieved only after two or three complete charge and discharge cycles. The battery can be charged and discharged hundreds of times, but it will eventually wear out. When the talk and standby times are noticeably shorter than normal, buy a new battery. Use only Acer approved batteries, and recharge your battery only with Acer approved chargers designated for this device.

Unplug the charger from the electrical plug and the device when not in use. Do not leave a fully charged battery connected to the AC adapter, since overcharging may shorten its lifetime. If left unused, a fully charged battery will lose its charge over time. If the battery is completely discharged, it

may take a few minutes before the charging indicator appears on the display or before any calls can be made.

Use the battery only for its intended purpose. Never use any charger or battery that is damaged.

Do not short-circuit the battery. Accidental short-circuiting can occur when a metallic object such as a coin, clip, or pen causes direct connection of the positive (+) and negative (-) terminals of the battery. (These look like metal strips on the battery.)

This might happen, for example, when you carry a spare battery in your pocket or purse. Short-circuiting the terminals may damage the battery or the connecting object.

Leaving the battery in hot or cold places, such as in a closed car in summer or winter conditions, will reduce the capacity and lifetime of the battery. Always try to keep the battery between 15 °C and 25 °C (59 °F and 77 °F). A device with a hot or cold battery may not work temporarily, even when the battery is fully charged. Battery performance is particularly limited in temperatures well below freezing.

Do not dispose of batteries in a fire as they may explode. Batteries may also explode if damaged. Dispose of batteries according to local regulations. Please recycle when possible. Do not dispose as household waste.

Replacing the battery pack

Your smartphone uses lithium batteries. Replace the battery with the same type as that which came bundled with your product. Use of another battery may present a risk of fire or explosion.



.....
CAUTION! Risk of explosion if battery is replaced by an incorrect type. Dispose of used batteries according to the instructions.
.....

Additional safety information

Your device and its enhancements may contain small parts. Keep them out of the reach of small children.

Operating environment



.....
Warning! For safety reasons, turn off all wireless or radio transmitting devices when using your smartphone device under the following conditions. These devices may include, but are not limited to: wireless LAN (WLAN), Bluetooth and/or 3G.
.....

Remember to follow any special regulations in force in any area, and always switch off your device when its use is prohibited or when it may cause interference or danger. Use the device only in its normal operating positions. This device meets RF exposure guidelines when used normally, and it and its antenna are positioned at least 1.5 cm (5/8") away from your body. Do not cover the antenna with metal and you should position the device at the above-stated distance from your body. To successfully transmit data files or messages, this device requires a good quality connection to the network. In some cases, transmission of data files or messages may be delayed until such a connection is available. Ensure that the above separation distance instructions are followed until the transmission is completed. Parts of the device are magnetic. Metallic materials may be attracted to the device, and persons with hearing aids should not hold the device to the ear with the hearing aid. Do not place credit cards or other magnetic storage media near the device, because information stored on them may be erased.

Medical devices

Operation of any radio transmitting equipment, including wireless phones, may interfere with the functionality of inadequately protected medical devices. Consult a physician or the manufacturer of the medical device to determine if they are adequately shielded from external RF energy or if you have any questions. Switch off your device in health care facilities when any regulations posted in these areas instruct you to do so. Hospitals or health care facilities may be using equipment that could be sensitive to external RF transmissions.

Pacemakers. Pacemaker manufacturers recommend that a minimum separation of 15.3 cm (6") be maintained between wireless devices and a pacemaker to avoid potential interference with the pacemaker. These recommendations are consistent with the independent research by and recommendations of Wireless Technology Research. Persons with pacemakers should do the following:

- Always keep the device more than 15.3 cm (6") from the pacemaker.
- Not carry the device near your pacemaker when the device is switched on. If you suspect interference, switch off your device, and move it.

Hearing aids. Some digital wireless devices may interfere with some hearing aids. If interference occurs, consult your service provider.

Vehicles

RF signals may affect improperly installed or inadequately shielded electronic systems in motor vehicles such as electronic fuel injection systems, electronic antiskid (antilock) braking systems, electronic speed control systems, and air bag systems. For more information, check with the manufacturer, or its representative, of your vehicle or any equipment that has been

added. Only qualified personnel should service the device, or install the device in a vehicle. Faulty installation or service may be dangerous and may invalidate any warranty that may apply to the device. Check regularly that all wireless equipment in your vehicle is mounted and operating properly. Do not store or carry flammable liquids, gases, or explosive materials in the same compartment as the device, its parts, or enhancements. For vehicles equipped with an air bag, remember that air bags inflate with great force. Do not place objects, including installed or portable wireless equipment in the area over the air bag or in the air bag deployment area. If in-vehicle wireless equipment is improperly installed, and the air bag inflates, serious injury could result. Using your device while flying in aircraft is prohibited. Switch off your device before boarding an aircraft. The use of wireless teledevices in an aircraft may be dangerous to the operation of the aircraft, disrupt the wireless telephone network, and may be illegal.

Potentially explosive environments

Switch off your device when in any area with a potentially explosive atmosphere and obey all signs and instructions. Potentially explosive atmospheres include areas where you would normally be advised to turn off your vehicle engine. Sparks in such areas could cause an explosion or fire resulting in bodily injury or even death. Switch off the device at refueling points such as near gas pumps at service stations. Observe restrictions on the use of radio equipment in fuel depots, storage, and distribution areas; chemical plants; or where blasting operations are in progress. Areas with a potentially explosive atmospheres are often, but not always, clearly marked. They include below deck on boats, chemical transfer or storage facilities, vehicles using liquefied petroleum gas (such as propane or butane), and areas where the air contains chemicals or particles such as grain, dust or metal powders.

Follow any restrictions. Do not use the device where blasting is in progress.

Emergency calls

Important: Wireless phones, including this device, operate using radio signals, wireless networks, landline networks, and user-programmed functions. Because of this, connections in all conditions cannot be guaranteed. You should never rely solely on any wireless device for essential communications like medical emergencies.

To make an emergency call:

1. If the device is not on, switch it on. Check for adequate signal strength. Some networks may require that a valid SIM card is properly inserted in the device.
2. Press the End button as many times as needed to clear the display and ready the device for calls.
3. Enter the official emergency number for your present location. Emergency numbers vary by location.
4. Press the Call button.

If certain features are in use, you may first need to turn those features off before you can make an emergency call. Consult this guide or your service provider for more information.

When making an emergency call, give all the necessary information as accurately as possible. Your wireless device may be the only means of communication at the scene of an accident. Do not end the call until given permission to do so.

Disposal and recycling information

Do not throw this electronic device into the trash when discarding.

To minimize pollution and ensure utmost protection of the global environment, please recycle. For more information on the Waste from Electrical and Electronics Equipment (WEEE) regulations, visit

www.acer-group.com/public/Sustainability/sustainability01.htm



Mercury advisory

For projectors or electronic products containing an LCD/CRT monitor or display:

Lamp(s) inside this product contain mercury and must be recycled or disposed of according to local, state or federal laws. For more information, contact the Electronic Industries Alliance at www.eiae.org. For lamp-specific disposal information, check www.lamprecycle.org.



Taking care of your smartphone

1. **DO** take care not to scratch the screen of your smartphone. Keep the screen clean. When working with your smartphone, use your finger or fingernail. Never use an actual pen or pencil or other sharp object on the screen surface.

2. **DO NOT** expose your smartphone to rain or moisture. Do not let water enter the circuitry through the front panel buttons or expansion slots. In general, treat your smartphone as you would a mobile phone or other small electronic device.
3. **DO** be careful not to drop your smartphone or subject it to any strong impact. Do not place your smartphone in your back pocket.
4. **DO NOT** expose your smartphone to extreme temperatures. For example, do not leave your smartphone on the dashboard of a car on a hot day or when temperatures are below freezing point. Also, keep it away from heaters and other sources of heat.
5. **DO NOT** use or store your smartphone in any location that is dusty, damp or wet.
6. **DO** use a soft, damp cloth to clean your smartphone. If the surface of the screen becomes soiled, clean it with a soft cloth moistened with diluted window-cleaning solution.
7. **DO NOT** press down on the screen with force, otherwise you may crack the screen.

Safety regulations

Compliant with Russian regulatory certification



LCD pixel statement

The LCD unit is produced with high-precision manufacturing techniques. Nevertheless, some pixels may occasionally misfire or appear as black or red dots. This has no effect on the recorded image and does not constitute a malfunction.

Radio device regulatory notice



.....
Note: Regulatory information below is for models with wireless LAN and/or Bluetooth only.
.....

General

This product complies with the radio frequency and safety standards of any country or region in which it has been approved for wireless use. Depending on configuration, this product may or may not contain wireless radio devices (such as wireless LAN and/or Bluetooth modules). Information below is for products with such devices.

Wireless operation channels for different domains

N. America	2.412-2.462 GHz	Ch01 through Ch11
Japan	2.412-2.484 GHz	Ch01 through Ch14
Europe ETSI	2.412-2.472 GHz	Ch01 through Ch13

France: Restricted wireless frequency bands

Some areas of France have a restricted frequency band. The worst case maximum authorized power indoors are:

- 10 mW for the entire 2.4 GHz band (2400 MHz - 2483.5 MHz)
- 100 mW for frequencies between 2446.5 MHz and 2483.5 MHz



.....
Note: Channels 10 through 13 inclusive operate in the band 2446.6 MHz to 2483.5 MHz.
.....

There are few possibilities for outdoor use: On private property or on the private property of public persons, use is subject to a preliminary authorization procedure by the Ministry of Defense, with maximum authorized power of 100 mW in the 2446.5 - 2483.5 MHz band. Use outdoors on public property is not permitted.

In the departments listed below, for the entire 2.4 GHz band:

- Maximum authorized power indoors is 100 mW
- Maximum authorized power outdoors is 10 mW

Departments in which the use of the 2400 - 2483.5 MHz band is

permitted with an EIRP of less than 100 mW indoors and less than 10 mW outdoors:

01 Ain Orientales	02 Aisne	03 Allier
05 Hautes Alpes	08 Ardennes	09 Ariège
11 Aude	12 Aveyron	16 Charente
24 Dordogne	25 Doubs	26 Drome
32 Gers	36 Indre	37 Indre et Loire
41 Loir et Cher	45 Loret	50 Manche
55 Meuse	58 Nievre	59 Nord
60 Oise	61 Orne	63 Puy Du Dome
64 Pyrenees Atlantique	66 Pyrenees	67 Bas Rhin
68 Haut Rhin	70 Haute Saone	71 Saone et Loire
75 Paris	82 Tarn et Garonne	84 Vaucluse
88 Vosges	89 Yonne	90 Territoire de Belfort
94 Val de Marne		

This requirement is likely to change over time, allowing you to use your wireless LAN card in more areas within France. Please check with ART for the latest information (www.art-telecom.fr).



.....
Note: Your WLAN Card transmits less than 100 mW, but more than 10 mW.
.....

Certificate Information (SAR)

This device meets the EU requirements (1999/519/EU) on the limitation of exposure of the general public to electromagnetic fields by way of health protection.

The limits are part of extensive recommendations for the protection of the general public. These recommendations have been developed and checked by independent scientific organizations through regular and thorough evaluations of scientific studies. To guarantee the safety of all persons, regardless of age and health, the limits include a significant safety buffer.

Before radio devices can be put in circulation, their agreement with European laws or limits must be confirmed; only then may the CE symbol be applied.

The unit of measurement for the European Council's recommended limit for mobile telephones is the "Specific Absorption Rate" (SAR). This SAR limit is 2.0 W/kg, averaged over 10 g of body tissue. It meets the requirements of the International Commission on Non-Ionizing Radiation Protection (ICNIRP) and was included in the European Standard EN 50360 for mobile radio devices. The SAR regulation for mobile telephones is in line with European Standard EN 62209-1. The maximum SAR value is calculated at the highest output level in all frequency bands of the mobile telephone. During use, the actual SAR level is usually much lower than the maximum value, because the mobile telephone works in different output levels. It only transmits with as much output as is required to reach the network. In general the following applies: The closer you are to a

base station, the lower the transmission output of your mobile telephone. The tested SAR of this device is as follows:

CE		NCC	
Head (W/kg 10g)	Body (W/kg 10g)	Head (W/kg 10g)	Body (W/kg 10g)
0.433	0.901 (1.5 cm)	0.433	NA

NCC warning

警語

經型式認證合格之低功率射頻電機，非經許可，公司、商號或使用者均不得擅自自變更頻率，加大功率或變更原設計之特性及功能

低功率射頻電機之使用不得影響飛航影響安全及干擾合法通信，經發現有干擾現象時，應立即停用，並改善至無干擾時方得繼續使用

前項合法通信，指一電信法規定作業之無線電通信低功率射頻電機需忍受合法通信或工業，科學及醫療用電波輻射性電機設備之干擾

Lithium-ion battery warning



ATTENZIONE! Rischio di esplosione della batteria se sostituita in modo errato. Sostituire la batteria con una di tipo uguale o equivalente consigliata dalla fabbrica. Non disperdere le batterie nell'ambiente.



VORSICHT! Explosionsgefahr bei unsachgemäßen Austausch der Batterie. Ersatz nur durch denselben oder einem vom Hersteller empfohlenem ähnlichen Typ. Entsorgung gebrauchter Batterien nach Angaben des Herstellers.



ADVARSELI! Lithiumbatteri - Eksplosionsfare ved fejlagtig håndtering. Udskiftning må kun ske med batteri af samme fabrikat og type. Levér det brugte batteri tilbage til leverandøren.



WARNING! Explosionsfara vid felaktigt batteribyte. Använd samma batterityp eller en ekvivalent typ som rekommenderas av apparattillverkaren. Kassera använt batteri enligt fabrikantens instruktion.



VAROITUS! Paristo voi räjähtää, jos se on virheellisesti asennettu. Vaihda paristo ainoastaan laitevalmistajan suositteluun tyypin. Hävitä käytetty paristo valmistajan ohjeiden mukaisesti.



ATTENTION ! Il y a danger d'explosion s'il y a remplacement incorrect de la batterie. Remplacer uniquement avec une batterie du même type ou d' un type équivalent recommandé par le constructeur. Mettre au rebut les batteries usagées conformément aux instructions du fabricant.



ADVARSEL! Eksplosjonsfare ved feilaktig skifte av batteri. Benytt samme batteritype eller en tilsvarende type anbefalt av apparatfabrikanten. Brukte batterier kasseres i henhold til fabrikantens instruksjoner.

Date: August 14, 2009

Declaration of Conformity

We, Acer Incorporated,
of 8F., No. 88, Sec. 1, Hsin Tai Wu Rd. Hsichih Taipei Hsien 221, Taiwan

Declare under sole responsibility that the product:

Model: S200

Description: Smart HandHeld

To which this declaration relates, is in conformity with the following standards and/or other normative documents:

- EN 301 511 V9.0.2
- EN 300 328 V1.7.1
- EN 301 908-1/-2 V3.2.1
- EN 300 440-1 V1.4.1/ EN300 440-2 V1.2.1
- EN 301 489-1 V1.8.1/-3 V1.4.1/-7 V1.3.1/-17 V1.3.2/-24 V1.4.1
- EN 55022:2006+ A1:2007 Class B; EN 55024:1998/A1:2001/A2:2003
- EN 55013:2001/A1:2003/A2:2006; EN 55020:2007
- EN 60950-1:2006
- EN 50332-1:2000/-2: 2003
- EN 50360:2001/ EN 62209-1:2006/ EN62311:2008/ OET65C

We hereby declare that the above named product is in conformance with all the essential requirements of the R&TTE Directive (99/5/EC) issued by the Commission of the European Community.

The conformity assessment procedure referred to in Article 10 and detailed in Annex [IV] of directive 1999/5/EC has been followed related to Articles

- R&TTE Article 3.1 (a) Health and Safety
- R&TTE Article 3.1 (b) EMC
- R&TTE Article 3.2 Spectrum Usage

with the involvement of the following Notified Body:

CETECOM, Untertuerkheimer Str. 6 – 10 66117 Saarbruecken

Identification mark: **0682** (Notified Body) CE

The technical documentation relevant to the above equipment will be held at:

Acer Incorporated
8F., No. 88, Sec. 1, Hsin Tai Wu Rd. Hsichih Taipei Hsien 221, Taiwan
Authorized Person:



Name: Harriot Lee

A	E
agenda 57	error messages 78
application buttons 64	F
B	FAQs 77
backlight settings 65	features 5
battery	flight mode 45
<i>charging</i> 13	G
<i>information</i> 80	GPRS 47, 72
Bluetooth	H
<i>connections</i> 49	help
<i>headset</i> 71	<i>sources</i> 6
<i>sending contacts</i> 54	I
C	input options 29
call forwarding 51	international numbers 21
call history 20	L
<i>options</i> 25	LED indicators 12, 14
call waiting 51	M
caller ID 51	MMS messages 33
calls	N
<i>answering</i> 23	naming 63
<i>ending</i> 23	network
<i>from other applications</i> .. 21	<i>selecting</i> 47
<i>onscreen options</i> 23	O
<i>putting on hold</i> 23	onscreen keyboard 27
<i>rejecting</i> 23	onscreen number pad 20
<i>swapping between</i> 23	P
camera	performance 79
<i>editing photo</i> 43	phone
<i>icons and indicators</i> 39	<i>connections</i> 46
<i>information</i> 80	photos & videos
<i>shooting a video</i> 41	<i>editing</i> 43
<i>supported formats</i> 41	power management 48
<i>taking a photo</i> 40	R
connecting to a PC 56	regional settings 67
connectivity 80	S
contacts	safety regulations 82
<i>adding and editing</i> 52	screen options 68
<i>assigning ring tones</i> 54	SD card 75
<i>deleting</i> 54	<i>information</i> 80
<i>making calls to a contact</i> 20	SIM manager 55
D	software
dimensions 80	
display 79	

<i>removing</i>	67	USB connector	79
sounds and notifications	65	V	
speakerphone	24	views	10
specifications	79	voice calls	
stylus	27	<i>the voice call screen</i>	22
system certificates	66	volume	
T		<i>adjusting</i>	64
tasks	58	W	
troubleshooting	77	windows media player	60
turning on	15	WLAN	
U		<i>settings</i>	48
unpacking	9	word completion	28